

# DOLI 90x200

Art.-Nr.

398 676  
398 677  
398 678  
398 679

↔ 936  
↕ 787  
↗ 2032  
mm

1/6  
VO  
36-2024

--	--	--	--	--	--	--	--	--

ID EE	ID			
21586	②	936*780*16	1x	1/4
21587	③	2000*390*16	1x	2/4
21588	④	2000*390*16	1x	2/4
21589	⑤	936*392*16	1x	1/4
21590	⑥	676*928*3	3x	1/4
			1x	3/4
			1x	4/4

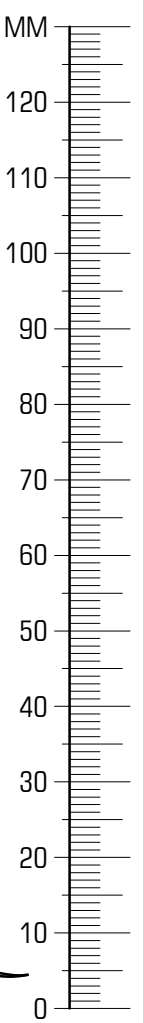
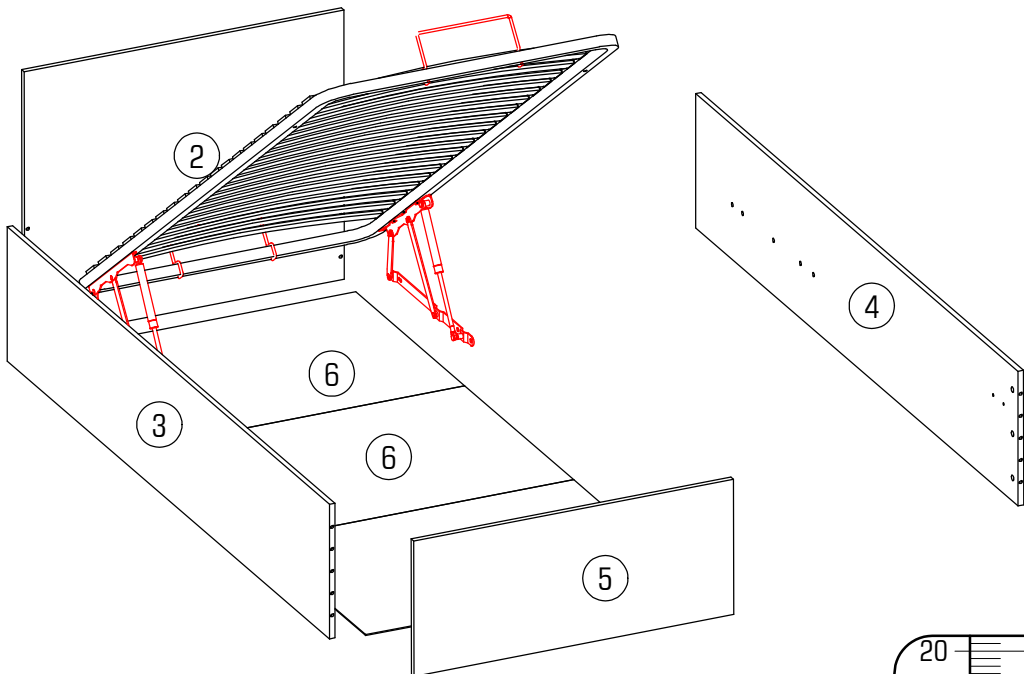
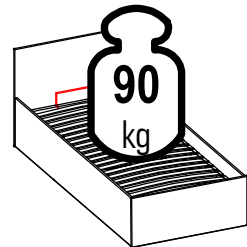

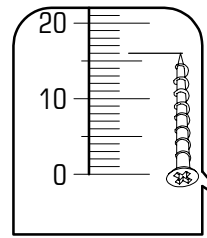

--	--	--	--





A 75x	B 8x	C 10x	D 6x	E 2x	F 2x	G 1x
J 1x	K 10x	L 8x	M 6x	N 6x	P 6x	Q1 6x
Q2 6x	R 2x	T 4x	U 4x	V 1x	W 1x	X 4x

--	--	--	--	--	--	--	--	--

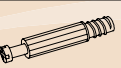
# 2/6 DOLI 90x200

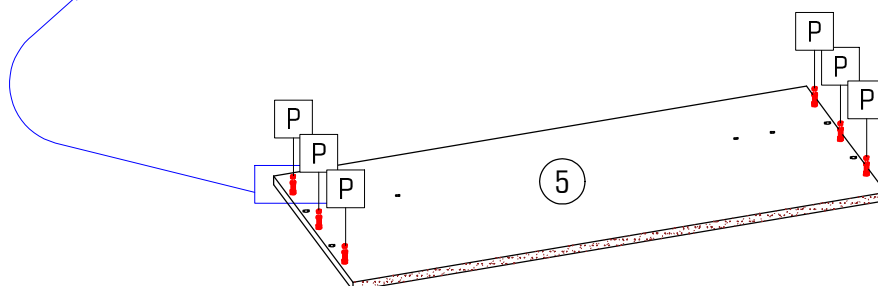
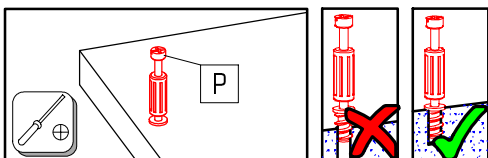
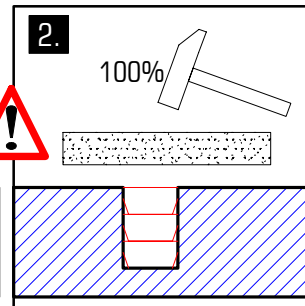
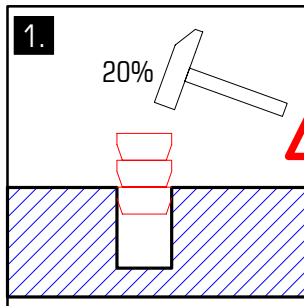
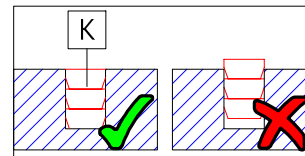
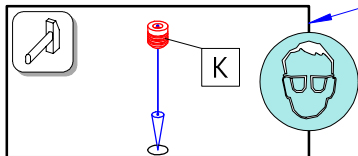
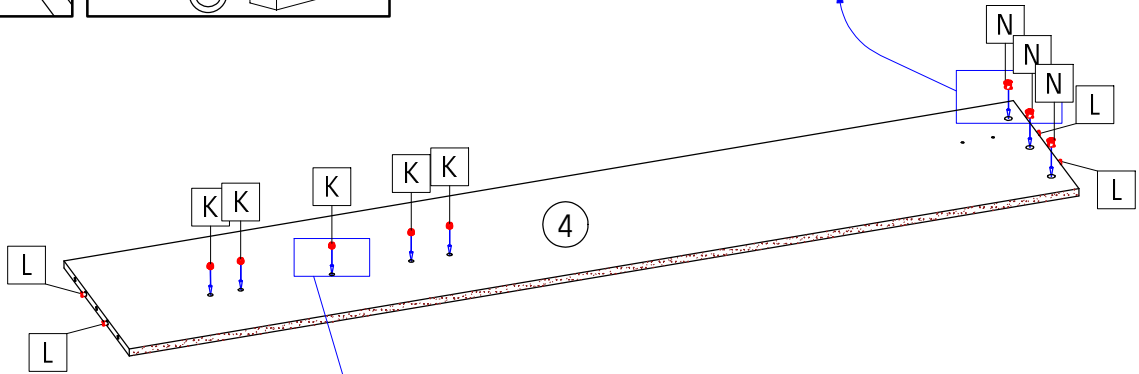
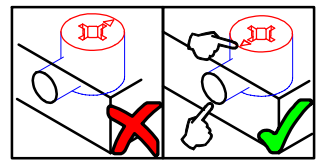
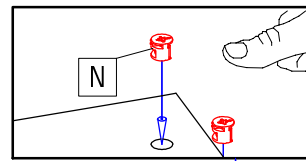
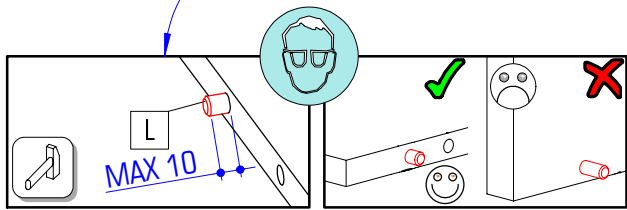
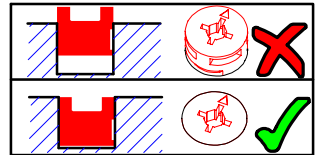
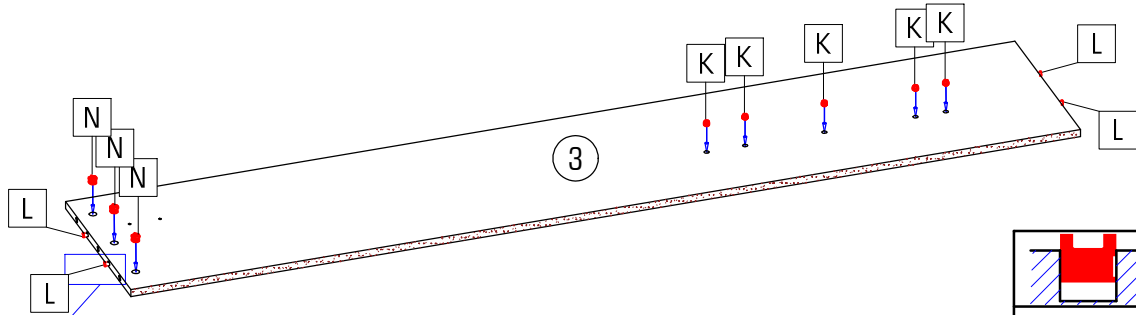
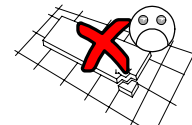
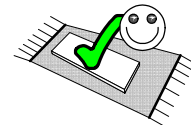

			
Ø10x11	Ø8x30	Ø15x13	
K 10x	L 8x	N 6x	P 6x

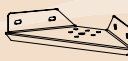

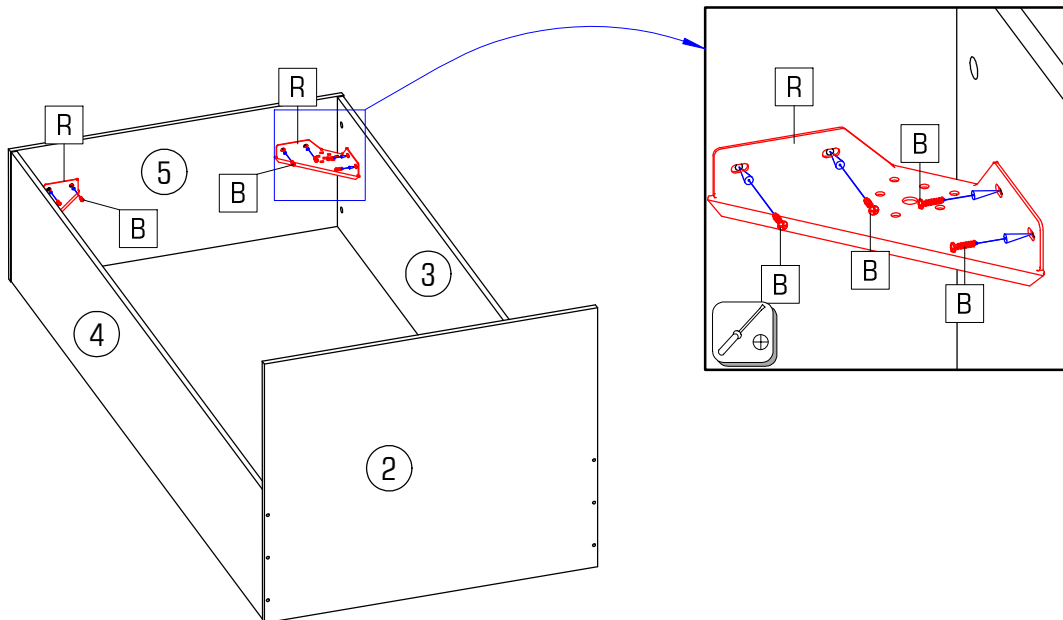
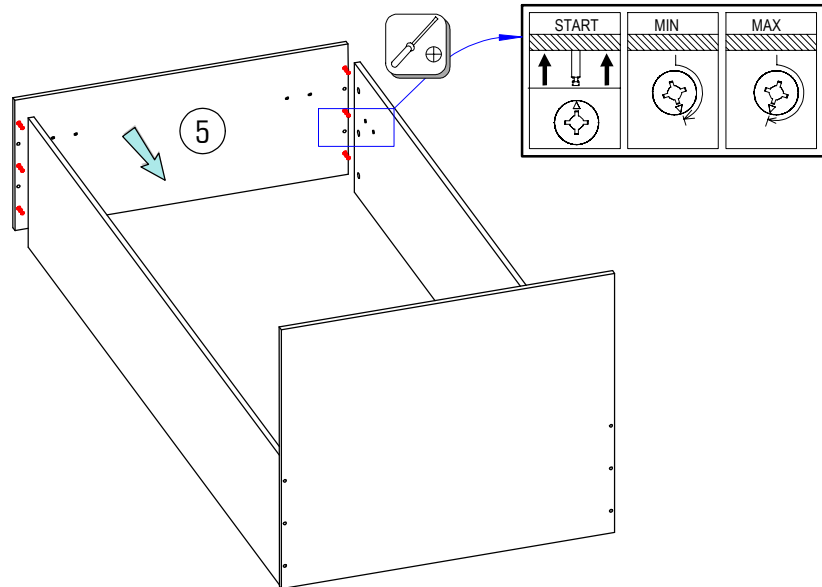
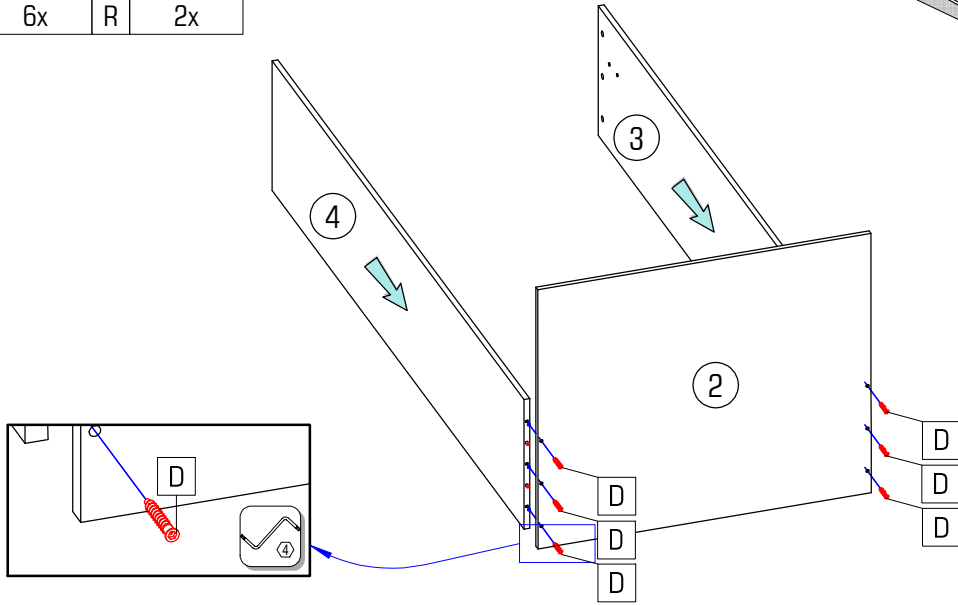
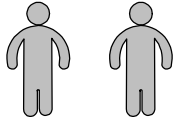
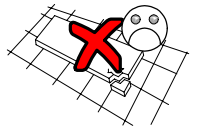
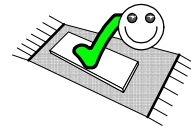

		
B	D	R
8x	6x	2x



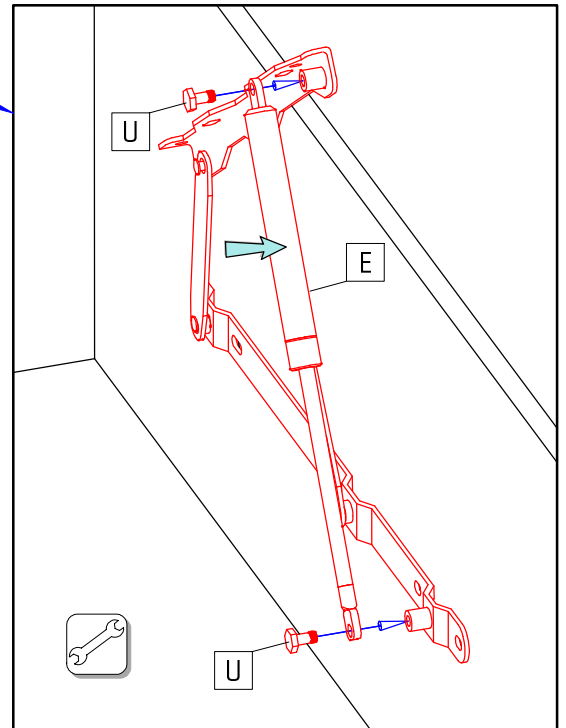
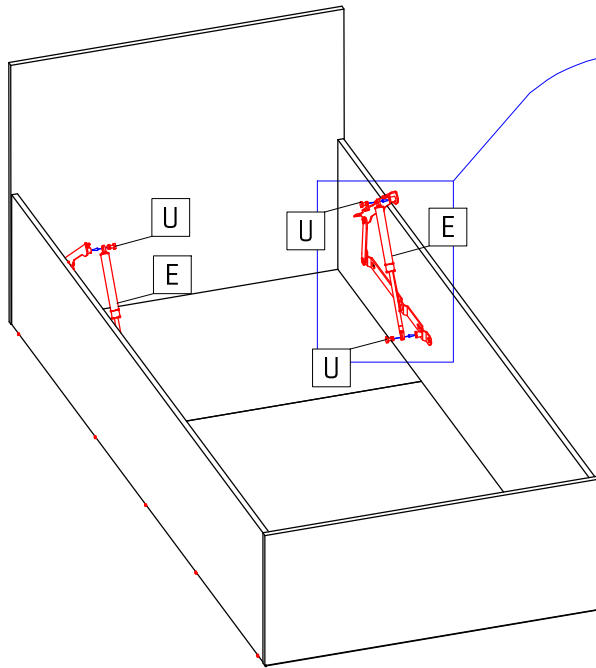

	
750 N	
E 2x	U 4x



	
F 2x	H 1x

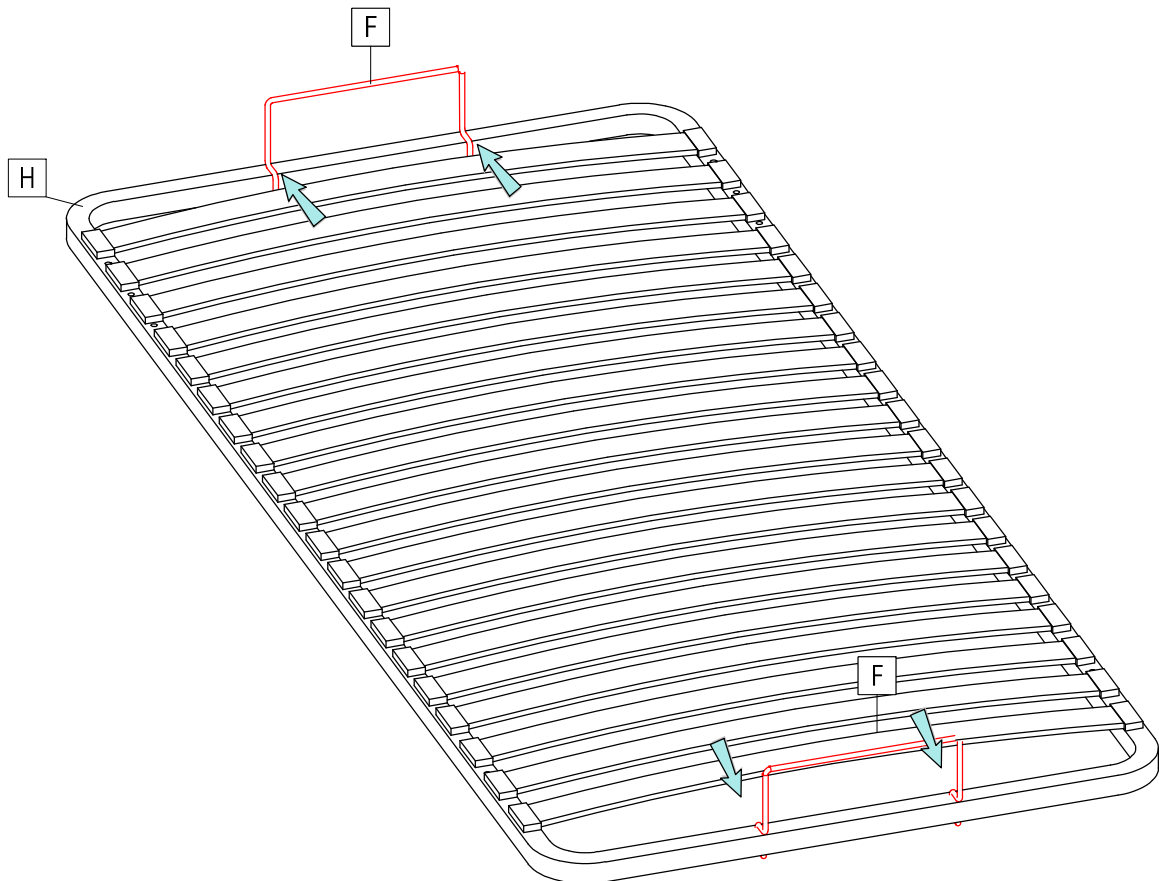

# 6/6 DOLI 90x200

Q1	6x	Q2	6x
T	4x	X	4x
	M6,0x40		M6,0

